



# ***CKS.08***

## ***CATÁLOGO CARCASAS***

## ***KEY SHELLS CATALOGUE***



**A5** **JMA es Compromiso**  
*JMA Konpromisoa da*  
*JMA is Commitment*  
*JMA, l'engagement*  
*JMA bedeutet Verpflichtung*

**A6** **ADVERTENCIA LEGAL**  
*Lege-abisua*  
*Legal warning*  
*Texte Legal*  
*Rechtlicher Hinweis*  
*Advertência legal*  
*Nota prawna*

**A7** **SIMBOLOGÍA**  
*Sinbologia*  
*Symbols*  
*Symbologie*  
*Symbole*  
*Simbologia*  
*Symbolika*

**A8-A10** **ÍNDICE**  
*Aurkibidea*  
*Index*  
*Index*  
*Hauptmarke*  
*Índice*  
*Spis marek*

**1 - 77** **LLAVES**  
*GILTZAK*  
*KEYS*  
*CLES*  
*SCHLÜSSEL*  
*CHAVES*  
*KLUCZE*

2 *ALFA ROMEO®*  
 3- 4 *AUDI®*  
 5 - 7 *BMW®*  
 7 - 9 *CHEVROLET®*  
 9- 12 *CHRYSLER®*  
 12 - 20 *CITROEN®*  
 20 *COBRA®*  
 20 - 21 *DACIA®*  
 21 - 27 *FIAT®*  
 27 - 29 *FORD®*  
 29- 32 *HONDA®*  
 32 - 35 *HYUNDAI®*  
 35 *ISUZU®*  
 35 *IVECO®*  
 36-37 *LANCIA®*  
 37 *LAND RANGE ROVER®*  
 37- 39 *LEXUS®*  
 39 - 40 *MAZDA®*  
 40 - 42 *MERCEDES®*  
 42 - 43 *MINI®*  
 43 - 45 *MITSUBISHI®*  
 45 - 46 *NISSAN®*  
 46 - 50 *OPEL®*  
 50 - 58 *PEUGEOT®*  
 59 - 63 *RENAULT®*  
 64 *ROVER®*  
 64 *SAAB®*  
 65 *SEAT®*  
 66 *SKODA®*  
 67 - 68 *SMART®*  
 68 *SSANGYONG®*  
 68 - 70 *SUBARU®*  
 70 - 71 *SUZUKI®*  
 71 - 75 *TOYOTA®*  
 75 - 77 *VOLKSWAGEN*

**79 -84** **OTROS**  
*BESTE BATZUK*  
*OTHERS*  
*AUTRES*  
*ANDERE*  
*OUTRAS*  
*INNE*

**80- 81** **ESPADINES**  
*EZPATA*  
*BLADES*  
*LAMES*  
*ZUNGE*  
*LAMINA*  
*GROTY*

**82 - 83** **TL**  
*TL*  
*HORSESHOES*  
*INSERTS*  
*TL*  
*TL*  
*TL*

**84** **ACCESORIOS**  
*OSAGARRIAK*  
*ACCESSORIES*  
*ACCESSOIRES*  
*ZUBEHÖRTEILE*  
*ACESSORIOS*  
*AKCESORIA*





## NUESTRO ÉXITO ESTÁ BASADO EN EL COMPROMISO DE LAS PERSONAS

## OUR SUCCESS IS BASED ON OUR PEOPLE'S COMMITMENT

JMA Alejandro Altuna S.L.U. es la sociedad matriz e impulsora de Altuna Group. Fabrica todo tipo de llaves para cerradura así como máquinas duplicadoras. Sus productos van destinados al mercado OEM y a la reposición, en este caso con la marca JMA.

Fundada por el Sr. Alejandro Altuna en 1942 arrancó su actividad en Mondragón. Posteriormente, la estrategia de apertura de mercados exteriores apoyada en la internacionalización y siempre basada en un enfoque innovador de los procesos industriales, ha convertido a ALTUNA GROUP en el primer productor de llaves europeo y referente mundial en este campo.

Actualmente, 15 compañías en 4 continentes trabajan conjuntamente para el desarrollo y potenciación de la fuerza de nuestra marca JMA, conocida en más de 100 países en todo el mundo.

JMA integra equipos de personas comprometidas y motivadas por un proyecto común que nos ha permitido ser el mayor fabricante de llaves de Europa.

JMA Alejandro Altuna S.L.U. is the parent company and driving force behind the Altuna Group. It manufactures all types of lock-keys and key-cutting machines. Its products are for the OEM and replacement markets, in the latter case with the JMA brand.

Set up by Alejandro Altuna in 1942, it started the production in Mondragón (Spain). Later, the strategy of opening up to foreign markets backed by globalisation and always based on an innovative attitude towards industrial processes, turned the ALTUNA GROUP into the largest producer of keys in Europe and a benchmark worldwide in the field.

Currently 15 companies in four continents work together to develop the strength of our JMA brand, well known in more than 100 countries all over the world.

This successful trail that led us to be the biggest key producer in Europe is based in our people's commitment to be:

### LÍDER EN TECNOLOGÍA:

Una apuesta sólida por la calidad y la innovación basada en la automatización y garantía de procesos y soportada por una vocación inversora a largo plazo.



### THE LEADER IN TECHNOLOGY,

looking for the latest developments to improve the production processes together with a strong investment policy in all our plants to ensure the company's competitiveness and long-term future.

### LÍDER EN CALIDAD:

Nuestra política de calidad se basa en la prevención y planificación, mejora continua, satisfacción del cliente y participación de las personas. Además de la Certificación en Calidad de acuerdo a la ISO 9001, Alejandro Altuna S.A. acoge Sistemas de Gestión de la Calidad homologados por las empresas líderes del sector de automoción y residencial.



### THE LEADER IN QUALITY:

Our quality policy is based on prevention and planning, continuous improvement, customer satisfaction and people participation. In addition to Quality Certification to ISO 9001, Alejandro Altuna S.A. operates Quality Management Systems approved by the leading companies in the automotive and residential sectors.

### LÍDER EN EL COMPROMISO POR EL MEDIO AMBIENTE:

En JMA Alejandro Altuna S.L.U. las buenas prácticas medioambientales son la norma y no la excepción. Nuestro equipo forma parte de un proyecto de empresa respetuoso con el medioambiente y que colabora con el desarrollo sostenible de nuestro entorno. JMA Alejandro Altuna S.L.U. fue el primer fabricante mundial de llaves en conseguir en 2000 el certificado ISO 14001 para su Sistema de Gestión.



### THE LEADER IN THE COMMITMENT TO THE ENVIRONMENT:

At JMA Alejandro Altuna S.L.U. best environmental practice is the norm and not the exception. Our team is part of a business project that respects the environment and contributes to the sustainable development of our community. JMA Alejandro Altuna S.L.U. was the first key manufacturer in the world to achieve ISO 14001 certification for its management system in 2000.

### LÍDER EN SERVICIO:

La realidad de una empresa se demuestra en su capacidad por responder con la máxima celeridad y eficacia a las necesidades y exigencias de los clientes. Se encuentren donde se encuentren. Además, gracias a su amplia red de filiales y empresas distribuidoras repartidas por todo el mundo, le permite llegar a cualquier cliente, se cual sea su ubicación.



### THE LEADER IN SERVICE,

The efficiency of a company is shown in its capacity to respond with the maximum speed and effectiveness to the needs and requirements of its customers, wherever they are based. Moreover, with its extensive network of associate and distribution companies located throughout the world, the company can reach any customer, wherever based.

**ESPAÑOL**

Conforme a las disposiciones legales vigentes relativas a la propiedad industrial, las marcas o nombres comerciales indicados en este catálogo son propiedad exclusiva de los fabricantes de cilindros y cerraduras, así como de los fabricantes de automóviles. Dichas marcas o nombres comerciales se indican en calidad simplemente informativa con el fin de reconocer con rapidez la cerradura a la que corresponden nuestras piezas.

Este catálogo está reservado exclusivamente a profesionales de la reproducción de llaves que utilizan piezas JMA. Los datos referentes a los productos de este catálogo tienen carácter indicativo. Manteniendo siempre las características básicas, nos reservamos el derecho de realizar, sin previo aviso, modificaciones técnicas, estéticas o de otro tipo, por razones de evolución de los productos en cuestión.

**EUSKERA**

Industria-jabegoari dagozkion indarrean dauden lege-xedapenekin bat etorri, katalogo honetan ageri diren marka edo merkataritza-izenak zilindro eta sarraileen fabrikatzaileen jabego eskusibokoak dira, eta baita ibilgailuen fabrikatzaileena. Aipatutako markak edo merkataritza-izenak modu informatiboan soilik aipatzen dira, gure piezak zein sarrailekin doazen azkar jakin ahal izateko.

Katalogo hau JMA piezak erabiltzen dituzten giltzen bikoizketara dedikatzen diren profesionaleri zuzenduta dago. Katalogo honetako produktuei dagozkien datuak azalpen izaera dute. Beti, oinarrizko ezaugarriak mantenduz, aurreko abisurik gabe, produktu horiek eboluzionatzen dutelako, aldaketa teknikoak, estetikoak edo beste motatakoan egiteko eskubidea dugu.

**DEUTSCH**

Gemäß den geltenden gesetzlichen Bestimmungen bezüglich des gewerblichen Eigentums, der Marken oder Handelsnamen, die in diesem Katalog angegeben sind, sind diese ausschließliches Eigentum der Hersteller der Zylinder und Schlösser sowie der Fahrzeughersteller. Diese Marken oder Handelsnamen werden aus rein informativen Gründen angegeben, um die Schlösser, zu denen unsere Teile gehören, schneller zu erkennen.

Dieser Katalog ist ausschließlich für Fachleute auf dem Gebiet der Reproduktion von Schlüsseln gedacht, die Teile von JMA verwenden. Die Daten bezüglich der Produkte dieses Katalogs haben indikativen Charakter. Unter Beibehaltung der grundlegenden Charakteristiken behalten wir uns das Recht vor, ohne Vorankündigung technische, ästhetische oder sonstige Modifikationen aufgrund der Weiterentwicklung der fraglichen Produkte vorzunehmen.

**POLSKI**

Zgodnie z aktualnymi przepisami prawnymi związanymi z ochroną własności przemysłowej, marki i nazwy handlowe wymienione w tym katalogu są wyłączną własnością producentów wkładek i zamków, oraz producentów samochodów. Zarówno marki jak i nazwy handlowe są wykorzystywane jedynie w celu szybkiego rozpoznania zamka, któremu odpowiadają nasze produkty. Ten katalog jest zarezerwowany wyłącznie dla profesjonalistów kopiowania kluczy korzystających z produktów JMA. Informacje odnoszące się do produktów w katalogu mają charakter orientacyjny. Przy zachowaniu podstawowych parametrów, zastrzegamy sobie prawo, bez uprzedniego powiadomienia, do zmian technicznych, estetycznych lub innych, w celu poprawy produktów.

**ENGLISH**

In accordance to current legal dispositions related to industrial property, the brands or commercial names indicated in this catalogue are the exclusive property of the manufacturers of cylinders and locks, as well as the manufacturers of automobiles. These brands or commercial names are used as mere information in order to quickly recognise the lock to which our parts correspond.

This catalogue is exclusively reserved to professional key duplicators that use JMA pieces. The data referring to the products of this catalogue is merely informative. Always maintaining the basic characteristics, we reserve the right to making, without previous notification, technical, aesthetic or other types of modifications, for improvement reasons of the products in question.

**FRANÇAIS**

Conformément aux dispositions légales en vigueur relatives à la propriété industrielle, les marques ou les dénominations commerciales citées dans ce catalogue sont la propriété exclusive des fabricants de cylindres et de serrures ainsi que des constructeurs de voitures, autres constructeurs, distributeurs et utilisateurs. Ces marques ou dénominations commerciales sont indiquées à titre de simple information afin de connaître rapidement à quelle serrure nos ébauches sont destinées.

Ce catalogue est exclusivement réservé aux professionnels de la reproduction de clés, utilisant des ébauches JMA. Les renseignements sur les produits de ce catalogue sont donnés à titre indicatif. Tout en gardant les caractéristiques de base, nous nous réservons le droit d'apporter, sans préavis, des modifications techniques, esthétiques ou autres, dues à l'évolution des produits en question.

**POTUGUESE**

Em conformidade com as disposições legais vigentes sobre a propriedade industrial, as marcas ou nomes comerciais indicados neste catálogo são propriedade exclusiva dos fabricantes de cilindros e fechaduras, assim como dos fabricantes de automóveis. Ditas marcas ou nomes comerciais mencionam-se com propósitos meramente informativos, com o fim de reconhecer com rapidez a fechadura a que correspondem as nossas peças.

Este catálogo está reservado exclusivamente a profissionais da reprodução de chaves que utilizam peças JMA. Os dados referentes aos produtos deste catálogo têm carácter meramente indicativo. Mantendo sempre as características básicas, reservamo-nos o direito de realizar, sem prévio aviso, quaisquer modificações técnicas, estéticas ou de outro tipo, resultantes da evolução dos produtos em questão.



### Nº Botones

Botoiak znb.  
Number Buttons  
Nº Bouton  
Anz. Knöpfe  
Nº Botões  
Ilo. Przyciski

**1.**

**Ref. JMA**  
Erref. JMA  
Ref. JMA  
Ref. JMA  
Ref. JMA  
Ref. JMA  
Symbol JMA

**2.**

**Marca**  
Marka  
Brand  
Marque  
Marke  
Marca  
Marka

**3.**

**Imagen JMA**  
JMA irudia  
Image JMA  
Image JMA  
Bild JMA  
Imagem JMA  
Zdjęcie JMA

**4.**

**Imagen detallada**  
Irudi xehea  
Detailed image  
Image de detail  
Detailliertes bild  
Imagem detalhada  
Szczegółowe zdjęcie

**5.**

**Detalles pila**  
Pilaren xehetasunak  
Battery details  
Detail pile  
Detail batt  
Detalhes pila  
Informacje o baterii

**6.**

**Botones**  
Botoiak  
Buttons  
Bouton  
Knöpfe  
Botões  
Przyciski

**7.**

**Perfil**  
Perfila  
Profile  
Profil  
profil  
Perfil  
Profil

**8.**

**Espadin JMA**  
JMA ezpata  
JMA blade  
Lame JMA  
Zunge JMA  
Lamina JMA  
Grot JMA

**9.**

**Convertibilidad**  
Bihurgarritasuna  
Convertibility  
Convertible  
Konvertierbarkeit  
Convertibilidade  
Zamiennik



**Maletero**  
Maletategia  
Boot  
Coffre  
Kofferraum  
Mala  
Bagażnik



**Luz**  
Argia  
Light  
Phare  
Licht  
Luz  
Światła



**Pila en carcasa**  
Pila karkasan  
Battery in casing  
Pile sur coque  
Batterie im Rohling  
Pilha na carcaça  
Bateria w obudowie



**Detalles pila**  
Pilaren xehetasunak  
Battery details  
Detail pile  
Detail batt  
Detalhes pila  
Informacje o baterii



**Pila en circuito**  
Pila zirkuituan  
Battery in circuit  
Pile sur circuit  
Batterie im Kreislauf  
Pilha no circuito  
Bateria na układzie



**Escamoteable**  
Ezkutagarria  
Flipkey  
Cle escamotable  
Einziehbar  
Retratil  
Zamiennik

## FOR: ALFA ROMEO®

MLAF01	2
MLFI-16.P4	2
MLFI-16.P5	2

## FOR: AUDI®

MLAU01	2
MLAU02	2
MLAU03	2
MLAU04	3
MLAU05	3
MLAU06	3
MLAU07	3
MLHU-HAA.P2	3

## FOR: BMW®

MLBM01	3
MLBM02	4
MLBM-5.P1	4
MLBM-5.P2	4
MLBM-5.P3	4
MLBM-6.P2	4
MLBM-6.P3	4
MLBM-6.P4	5
MLBM-6.P5	5
MLBM-9.P	5

## FOR: CHEVROLET®

MLDAE-3D.P6	5
MLGM01	5
MLGM-49D.P1	5
MLOP-11.P6	6
MLOP-11.P8	6
MLOP-WH.P1	6
MLOP-WH.P2	6
MLOP-WH.P3	6

## FOR: CHRYSLER®

MLCHR01	6
MLCHR02	7
MLCHR03	7
MLCHR04	7
MLCHR05	7
MLCHR06	7
MLCHR-15.P2	7
MLCHR-15.P3	8
MLCHR-15.P4	8
MLCHR-15.P5	8
MLCHR-15.P6	8

## FOR: CITROEN®

MLCITO1	8
MLCITO2	8
MLCITO3	9
MLCITO4	9
MLCITO5	9
MLCIT-1.P1	9
MLCIT-1.P2	9
MLCIT-1.P3	9
MLCIT-1.P11	10
MLCIT-1.P4	10
MLCIT-1.P5	10
MLCIT-1.P6	10
MLCIT-1.P7	10
MLCIT-1.P10	10
MLCIT-1.P14	11
MLHU-HCA.P1	11
MLHU-HCA.P2	11
MLHU-HCA.P3	11
MLHU-HCA.P9	11
MLHU-HCA.P4	11
MLHU-HCA.P5	12
MLHU-HCA.P6	12
MLHU-HCA.P7	12
MLHU-HCA.P10	12
MLHU-HCA.P11	12
MLNE-38.P5	12
MLNE-38.P6	13
MLSIX-3.P4	13
MLSIX-3.P5	13
MLSIX-3.P6	13
MLSIX-3.P7	13
MLSIX-3.P8	13

## FOR: COBRA®

MLHOND01	14
----------	----

## FOR: DACIA®

MLDAC-4D.P1	14
MLDAC-6D.P1	14
MLVA-34.P8	14
MLVA-34.P9	14

## FOR: FIAT®

MLFI01	14
MLFI02	15
MLFI03	15
MLFI04	15
MLFI05	15

MLFI06	15
MLFI07	15
MLFI08	16
MLFI09	16
MLFI10	16
MLFI11	16
MLFI12	16
MLFI-13.P9	16
MLFI-13.P10	17
MLFI-16.P2	17
MLFI-16.P3	17
MLFI-16.P6	17
MLFI-16.P8	17
MLFI-16.P10	17
MLFI-16.P11	18
MLFI-16.P12	18
MLFI-16.P13	18
MLFI-16.P14	18
MLHU-HCA.P1	18
MLHU-HCA.P2	18

## FOR: FORD®

MLFO01	19
MLFO02	19
MLFO03	19
MLFO04	19
MLFO-24.P1	19
MLFO-24.P3	19
MLFO-24.P4	20

## FOR: HONDA®

MLHOND02	20
MLHOND03	20
MLHOND-31.P1	20
MLHOND-31.P2	20
MLHOND-31.P3	20
MLHOND-31.P4	21
MLHOND-31.P5	21
MLHOND-31.P6	21
MLHOND-31.P7	21
MLHOND-31.P8	21
MLHOND-31.P9	21

## FOR: HYUNDAI®

MLHY01	22
MLHY02	22
MLHY03	22
MLHY-11.P5	22
MLHY-11D.P2	22

MLHY-11D.P6	22
MLHY-11D.P7	23
MLHY-18.P2	23
MLHY-18.P4	23
MLHY-18.P5	23
MLHY-18.P6	23
MLHY-18.P7	23
MLHY-18.P8	24

## FOR: ISUZU®

MLISU-3D.P3	24
-------------	----

## FOR: IVECO®

MLFI-13.P11	24
-------------	----

## FOR: LANCIA®

MLFI-13.P10	24
MLFI-16.P3	24
MLHU-HCA.P5	24
MLHU-HCA.P7	25
MLHU-HCA.P8	25

## FOR: LAND RANGE ROVER®

MLNE-52.P3	25
------------	----

## FOR: LEXUS®

MLTOYO01	25
MLHU-HCA.P1	25
MLHU-HCA.P2	25
MLTOYO-15.P3	26
MLTOYO-15.P5	26
MLTOYO-15.P6	26
MLTOYO-19.P2	26
MLTOYO-30.P2	26
MLTOYO-36.P1	26

## FOR: MAZDA®

MLMAZ-11D.P3	27
MLMAZ-21D.P2	27
MLMAZ-21D.P3	27

## FOR: MERCEDES®

MLME01	27
MLME02	27
MLME03	27
MLME-2.P1	28
MLME-2.P2	28

MLME-2.P3	28	MLCIT-1.P11	35	MLRV01	42	MLKI-9.P1	48
MLME-7.P1	28	MLCIT-1.P4	35	MLBM-8.P3	43	MLCIT-1.P15	48
MLME-7.P2	28	MLCIT-1.P5	35	MLNE-52.P4	43	MLCIT-1.P16	48
MLME-7.P3	28	MLCIT-1.P6	35			MLTOYO-15.P3	48
		MLCIT-1.P7	35	<b>FOR: SAAB®</b>		MLTOYO-15.P4	48
<b>FOR: MINI®</b>		MLCIT-1.P10	35	MLSAA-3.P2	43	MLTOYO-15.P5	49
MLBM-8.P1	29	MLFI01	36			MLTOYO-15.P6	49
MLBM-8.P2	29	MLFI02	36	<b>FOR: SEAT®</b>		MLTOYO-15.P7	49
MLBM-8.P3	29	MLHU-HCA.P1	36	MLV001	43	MLTOYO-19.P1	49
		MLHU-HCA.P2	36	MLV002	43	MLTOYO-19.P2	49
		MLHU-HCA.P3	36	MLV003	43	MLTOYO-19.P3	49
<b>FOR: MITSUBISHI®</b>		MLHU-HCA.P9	36	MLV004	44	MLTOYO-20D.P2	50
MLMIT01	29	MLHU-HCA.P4	37			MLTOYO-20D.P3	50
MLMIT02	29	MLHU-HCA.P5	37	<b>FOR: SKODA®</b>		MLTOYO-30.P2	50
MLHU-DH.P4	29	MLHU-HCA.P6	37	MLV001	44	MLTOYO-36.P1	50
MLMIT-8D.P3	30	MLHU-HCA.P7	37	MLV002	44	MLTOYO-43.P1	50
MLMIT-8D.P4	30	MLHU-HCA.P8	37	MLV003	44		
MLMIT-8D.P5	30	MLNE-38.P5	37	MLV004	44	<b>FOR: VOLKSWAGEN®</b>	
MLMIT-12.P3	30	MLNE-38.P6	38			MLV001	50
MLMIT-12.P4	30	MLNE-38.P15	38	<b>FOR: SMART®</b>		MLV002	51
		MLNE-51.P3	38	MLSMR01	44	MLV003	51
		MLNE-51.P4	38	MLSMR02	45	MLV004	51
		MLNE-51.P5	38	MLSMR03	45	MLHU-HAA.P3	51
<b>FOR: NISSAN®</b>		MLNE-51.P6	38	MLME-HY.P1	45	MLHU-HAA.P4	51
MLNS01	30	MLSIX-3.P4	39	MLME-HY.P2	45	MLHU-HAA.P5	51
MLDAT-15.P6	31	MLSIX-3.P5	39	MLSMR-1.P1	45	MLHU-HAA.P6	52
MLDAT-15.P7	31	MLSIX-3.P7	39				
MLDAT-15.P8	31			<b>FOR: SSANGYONG®</b>			
		<b>FOR: RENAULT®</b>		MLSSA-1.P2	45		
<b>FOR: OPEL®</b>		MLCIT-1.P1	39				
MLOP01	31	MLCIT-1.P2	39	<b>FOR: SUBARU®</b>			
MLOP02	31	MLCIT-1.P8	39	MLSUB-2.P1	46		
MLOP03	31	MLCIT-1.P9	40	MLSUB-2.P3	46		
MLOP04	32	MLCIT-1.P12	40	MLSUB-2.P4	46		
MLOP05	32	MLCIT-1.P13	40	MLSUB-3.P3	46		
MLOP-11.P3	32	MLNE-38.P7	40	MLSUB-3.P4	46		
MLOP-11.P4	32	MLNE-38.P8	40	MLISU-3D.P4	46		
MLCIT-1.P8	32	MLNE-38.P9	40				
MLCIT-1.P9	32	MLNE-38.P10	41	<b>FOR: SUZUKI®</b>			
MLNE-38.P8	33	MLNE-38.P11	41	MLSUZU01	47		
MLNE-38.P11	33	MLNE-38.P12	41	MLSZ01	47		
MLNE-38.P12	33	MLNE-38.P13	41	MLSUZU-14.P3	47		
MLOP-11.P6	33	MLNE-38.P14	41	MLSUZU-14.P4	47		
MLOP-11.P7	33	MLVA-34.P5	41	MLTOYO-15.P9	47		
		MLVA-34.P6	42				
<b>FOR: PEUGEOT®</b>		MLVA-34.P7	42	<b>FOR: TOYOTA®</b>			
MLCIT01	33	MLVA-34.P8	42	MLTOYO01	47		
MLCIT02	34	MLVA-34.P9	42	MLTOYO02	48		
MLCIT03	34	MLVA-34.P10	42				
MLCIT04	34						
MLCIT-1.P1	34	<b>FOR: ROVER®</b>					
MLCIT-1.P2	34						
MLCIT-1.P3	34						



REF	PAG	REF	PAG	REF	PAG	REF	PAG
MLAF01	2	MLFI-13.P11	24	MLHU-HCA.P7	12 / 25 / 37	MLOP-11.P6	6 / 33
MLAU01	2	MLFI-13.P9	16	MLHU-HCA.P8	25 / 37	MLOP-11.P7	33
MLAU02	2	MLFI-16.P10	17	MLHU-HCA.P9	11 / 36	MLOP-11.P8	6
MLAU03	2	MLFI-16.P11	18	MLHY-11.P5	22	MLOP-WH.P1	6
MLAU04	3	MLFI-16.P12	18	MLHY-11D.P2	22	MLOP-WH.P2	6
MLAU05	3	MLFI-16.P13	18	MLHY-11D.P6	22	MLOP-WH.P3	6
MLAU06	3	MLFI-16.P14	18	MLHY-11D.P7	23	MLOP01	31
MLAU07	3	MLFI-16.P2	17	MLHY-18.P2	23	MLOP02	31
MLBM-5.P1	4	MLFI-16.P3	17 / 24	MLHY-18.P4	23	MLOP03	31
MLBM-5.P2	4	MLFI-16.P4	2	MLHY-18.P5	23	MLOP04	32
MLBM-5.P3	4	MLFI-16.P5	2	MLHY-18.P6	23	MLOP05	32
MLBM-6.P2	4	MLFI-16.P6	17	MLHY-18.P7	23	MLRV01	42
MLBM-6.P3	4	MLFI-16.P8	17	MLHY-18.P8	24	MLSAA-3.P2	43
MLBM-6.P4	5	MLFI01	14 / 36	MLHY01	22	MLSIX-3.P4	13 / 39
MLBM-6.P5	5	MLFI02	15 / 36	MLHY02	22	MLSIX-3.P5	13 / 39
MLBM-8.P1	29	MLFI03	15	MLHY03	22	MLSIX-3.P6	13
MLBM-8.P2	29	MLFI04	15	MLISU-3D.P3	24	MLSIX-3.P7	13 / 39
MLBM-8.P3	29 / 43	MLFI05	15	MLISU-3D.P4	46	MLSIX-3.P8	13
MLBM-9.P	5	MLFI06	15	MLKI-9.P1	48	MLSMR-1.P1	45
MLBM01	3	MLFI07	15	MLMAZ-11D.P3	27	MLSMR01	44
MLBM02	4	MLFI08	16	MLMAZ-21D.P2	27	MLSMR02	45
MLCHR-15.P2	7	MLFI09	16	MLMAZ-21D.P3	27	MLSMR03	45
MLCHR-15.P3	8	MLFI10	16	MLME-2.P1	28	MLSSA-1.P2	45
MLCHR-15.P4	8	MLFI11	16	MLME-2.P2	28	MLSUB-2.P1	46
MLCHR-15.P5	8	MLFI12	16	MLME-2.P3	28	MLSUB-2.P3	46
MLCHR-15.P6	8	MLFO-24.P1	19	MLME-7.P1	28	MLSUB-2.P4	46
MLCHR01	6	MLFO-24.P3	19	MLME-7.P2	28	MLSUB-3.P3	46
MLCHR02	7	MLFO-24.P4	20	MLME-7.P3	28	MLSUB-3.P4	46
MLCHR03	7	MLF001	19	MLME-HY.P1	45	MLSUZU-14.P3	47
MLCHR04	7	MLF002	19	MLME-HY.P2	45	MLSUZU-14.P4	47
MLCHR05	7	MLF003	19	MLME01	27	MLSUZU01	47
MLCHR06	7	MLF004	19	MLME02	27	MLSZ01	47
MLCIT-1.P1	9 / 34 / 39	MLGM-49D.P1	5	MLME03	27	MLTOYO-15.P3	26 / 48
MLCIT-1.P10	10 / 35	MLGMO1	5	MLMIT-12.P3	30	MLTOYO-15.P4	48
MLCIT-1.P11	10 / 35	MLHOND-31.P1	20	MLMIT-12.P4	30	MLTOYO-15.P5	26 / 49
MLCIT-1.P12	40	MLHOND-31.P2	20	MLMIT-8D.P3	30	MLTOYO-15.P6	26 / 49
MLCIT-1.P13	40	MLHOND-31.P3	20	MLMIT-8D.P4	30	MLTOYO-15.P7	49
MLCIT-1.P14	11	MLHOND-31.P4	21	MLMIT-8D.P5	30	MLTOYO-15.P9	47
MLCIT-1.P15	48	MLHOND-31.P5	21	MLMIT01	29	MLTOYO-19.P1	49
MLCIT-1.P16	48	MLHOND-31.P6	21	MLMIT02	29	MLTOYO-19.P2	26 / 49
MLCIT-1.P2	9 / 34 / 39	MLHOND-31.P7	21	MLNE-38.P10	41	MLTOYO-19.P3	49
MLCIT-1.P3	9 / 34	MLHOND-31.P8	21	MLNE-38.P11	33 / 41	MLTOYO-20D.P2	50
MLCIT-1.P4	10 / 35	MLHOND-31.P9	21	MLNE-38.P12	33 / 41	MLTOYO-20D.P3	50
MLCIT-1.P5	10 / 35	MLHOND01	14	MLNE-38.P13	41	MLTOYO-30.P2	26 / 50
MLCIT-1.P6	10 / 35	MLHOND02	20	MLNE-38.P14	41	MLTOYO-36.P1	26 / 50
MLCIT-1.P7	10 / 35	MLHOND03	20	MLNE-38.P15	38	MLTOYO-43.P1	50
MLCIT-1.P8	32 / 39	MLHU-DH.P4	29	MLNE-38.P5	12 / 37	MLTOY001	25 / 47
MLCIT-1.P9	32 / 40	MLHU-HAA.P2	3	MLNE-38.P6	13 / 38	MLTOY002	48
MLCIT01	8 / 33	MLHU-HAA.P3	51	MLNE-38.P7	40	MLVA-34.P10	42
MLCIT02	8 / 34	MLHU-HAA.P4	51	MLNE-38.P8	33 / 40	MLVA-34.P5	41
MLCIT03	9 / 34	MLHU-HAA.P5	51	MLNE-38.P9	40	MLVA-34.P6	42
MLCIT04	9 / 34	MLHU-HAA.P6	52	MLNE-51.P3	38	MLVA-34.P7	42
MLCIT05	9	MLHU-HCA.P1	11 / 18 / 25 / 36	MLNE-51.P4	38	MLVA-34.P8	14 / 42
MLDAC-4D.P1	14	MLHU-HCA.P10	12	MLNE-51.P5	38	MLVA-34.P9	14 / 42
MLDAC-6D.P1	14	MLHU-HCA.P11	12	MLNE-51.P6	38	MLV001	43 / 44 / 50
MLDAE-3D.P6	5	MLHU-HCA.P2	11 / 18 / 25 / 36	MLNE-52.P3	25	MLV002	43 / 44 / 51
MLDAT-15.P6	31	MLHU-HCA.P3	11 / 36	MLNE-52.P4	43	MLV003	43 / 44 / 51
MLDAT-15.P7	31	MLHU-HCA.P4	11 / 37	MLNS01	30	MLV004	44 / 51
MLDAT-15.P8	31	MLHU-HCA.P5	12 / 24 / 37	MLOP-11.P3	32		
MLFI-13.P10	17 / 24	MLHU-HCA.P6	12 / 37	MLOP-11.P4	32		



**LLAVES**  
**KEYS**

*GILTZAK* **CLES** *SCHLÜSSEL* **CHAVES** *KLUCZE*

**MLAF01 FOR: ALFA ROMEO®**



**MLFI-16.P4 FOR: ALFA ROMEO®**



**MLFI-16.P5 FOR: ALFA ROMEO®**



**MLAU01 FOR: AUDI®**



TPO0HU-HAA.TLV

**MLAU02 FOR: AUDI®**



TPO0HU-HAA.TLV

**MLAU03 FOR: AUDI®**



TPO0HU-HAA.TLV



**MLAU04 FOR: AUDI®**



TP00HU-HAA.TLV

**MLAU05 FOR: AUDI®**



**MLAU06 FOR: AUDI®**



**MLAU07 FOR: AUDI®**



**MLHU-HAA.P2 FOR: AUDI®**



**HU-HAAC4**

**MLBM01 FOR: BMW®**



**MLBM02 FOR: BMW<sup>®</sup>****2****MLBM-5.P1 FOR: BMW<sup>®</sup>** **3** **MLBM-5.P2 FOR: BMW<sup>®</sup>** **2****MLBM-5.P3 FOR: BMW<sup>®</sup>** **3** **MLBM-6.P2 FOR: BMW<sup>®</sup>** **3** **MLBM-6.P3 FOR: BMW<sup>®</sup>** **2**

**MLBM-6.P4 FOR: BMW®**



**MLBM-6.P5 FOR: BMW®**



BM-6.P5C1

**MLBM-9.P FOR: BMW®**



BM-9.P1C1

**MLDAE-3D.P6 FOR: CHEVROLET®**



**MLGM01 FOR: CHEVROLET®**



TP000P-WHTL2

**MLGM-49D.P1 FOR: CHEVROLET®**



**MLOP-11.P6 FOR: CHEVROLET®**



**MLOP-11.P8 FOR: CHEVROLET®**



**MLOP-WH.P1 FOR: CHEVROLET®**



**MLOP-WH.P2 FOR: CHEVROLET®**



**MLOP-WH.P3 FOR: CHEVROLET®**



**MLCHR01 FOR: CHRYSLER®**



**MLCHR02 FOR: CHRYSLER®**



**MLCHR03 FOR: CHRYSLER®**



**MLCHR04 FOR: CHRYSLER®**



**MLCHR05 FOR: CHRYSLER®**



**MLCHR06 FOR: CHRYSLER®**



**MLCHR-15.P2 FOR: CHRYSLER®**



**MLCHR-15.P3 FOR: CHRYSLER<sup>®</sup>****MLCHR-15.P4 FOR: CHRYSLER<sup>®</sup>****MLCHR-15.P5 FOR: CHRYSLER<sup>®</sup>****MLCHR-15.P6 FOR: CHRYSLER<sup>®</sup>****MLCITO1 FOR: CITROEN<sup>®</sup>****MLCITO2 FOR: CITROEN<sup>®</sup>**

**MLCIT03 FOR: CITROEN®**



2

**MLCIT04 FOR: CITROEN®**



 2

**MLCIT05 FOR: CITROEN®**



3 

**MLCIT-1.P1 FOR: CITROEN®**



 2   
MLCIT-1.P2

**MLCIT-1.P2 FOR: CITROEN®**



 2   
PEU-1C1

**MLCIT-1.P3 FOR: CITROEN®**



 2   
PEU-1C1

**MLCIT-1.P11 FOR: CITROEN®**



PEU-1C1

**MLCIT-1.P4 FOR: CITROEN®**



PEU-1C1

**MLCIT-1.P5 FOR: CITROEN®**



PEU-1C1

**MLCIT-1.P6 FOR: CITROEN®**



PEU-1C1

**MLCIT-1.P7 FOR: CITROEN®**



PEU-1C1

**MLCIT-1.P10 FOR: CITROEN®**



PEU-1C1



**MLCIT-1.P14 FOR: CITROEN®**



**MLHU-HCA.P1 FOR: CITROEN®**



**MLHU-HCA.P2**

**MLHU-HCA.P2 FOR: CITROEN®**



**MLHU-HCA.P3 FOR: CITROEN®**



**MLHU-HCA.P9 FOR: CITROEN®**



**MLHU-HCA.P4 FOR: CITROEN®**



**MLHU-HCA.P5 FOR: CITROEN®**



**MLHU-HCA.P6 FOR: CITROEN®**



**MLHU-HCA.P7 FOR: CITROEN®**



**MLHU-HCA.P10 FOR: CITROEN®**



**MLHU-HCA.P11 FOR: CITROEN®**



**MLNE-38.P5 FOR: CITROEN®**



**NE-60C3**

**MLNE-38.P6 FOR: CITROEN®**



**MLSIX-3.P4 FOR: CITROEN®**



**MLSIX-3.P5 FOR: CITROEN®**



**MLSIX-3.P6 FOR: CITROEN®**



**MLSIX-3.P7 FOR: CITROEN®**



**MLSIX-3.P8 FOR: CITROEN®**



**MLHOND01 FOR: COBRA®**



**MLDAC-4D.P1 FOR: DACIA®**



DAC-4DC1

**MLDAC-6D.P1 FOR: DACIA®**



DAC-6DP

**MLVA-34.P8 FOR: DACIA®**



VA-61C3

**MLVA-34.P9 FOR: DACIA®**



VA-61C3

**MLFI01 FOR: FIAT®**



**MLFI02 FOR: FIAT®**



**MLFI03 FOR: FIAT®**



**MLFI04 FOR: FIAT®**



**MLFI05 FOR: FIAT®**



**MLFI06 FOR: FIAT®**



**MLFI07 FOR: FIAT®**



**MLFI08 FOR: FIAT<sup>®</sup>**



**MLFI09 FOR: FIAT<sup>®</sup>**



**MLFI10 FOR: FIAT<sup>®</sup>**



**MLFI11 FOR: FIAT<sup>®</sup>**



**MLFI12 FOR: FIAT<sup>®</sup>**



**MLFI-13.P9 FOR: FIAT<sup>®</sup>**



**MLFI-13.P10 FOR: FIAT®**



**MLFI-16.P2 FOR: FIAT®**



**MLFI-16.P3 FOR: FIAT®**



**MLFI-16.P6 FOR: FIAT®**



**MLFI-16.P8 FOR: FIAT®**



**MLFI-16.P10 FOR: FIAT®**



FI-16.P10C3

**MLFI-16.P11 FOR: FIAT<sup>®</sup>**



**MLFI-16.P12 FOR: FIAT<sup>®</sup>**



**MLFI-16.P13 FOR: FIAT<sup>®</sup>**



**MLFI-16.P14 FOR: FIAT<sup>®</sup>**



**MLHU-HCA.P1 FOR: FIAT<sup>®</sup>**



**MLHU-HCA.P2**

**MLHU-HCA.P2 FOR: FIAT<sup>®</sup>**





**MLFO01 FOR: FORD®**



TP00FO-6.TL  
TP00FO-24.TL

**MLFO02 FOR: FORD®**



TP00FO-6.TL2  
TP00FO-24.TL2}

**MLFO03 FOR: FORD®**



**MLFO04 FOR: FORD®**



TP00FO-6.TL  
TP00FO-24.TL

**MLFO-24.P1 FOR: FORD®**



**MLFO-24.P3 FOR: FORD®**



FO-24.P3C10

**MLFO-24.P4 FOR: FORD®**



FO-24C3

**MLHOND02 FOR: HONDA®**



**MLHOND03 FOR: HONDA®**



**MLHOND-31.P1 FOR: HONDA®**



**MLHOND-31.P2 FOR: HONDA®**



**MLHOND-31.P3 FOR: HONDA®**



**MLHOND-31.P4 FOR: HONDA®**



**MLHOND-31.P5 FOR: HONDA®**



**MLHOND-31.P6 FOR: HONDA®**



**MLHOND-31.P7 FOR: HONDA®**



**MLHOND-31.P8 FOR: HONDA®**



**MLHOND-31.P9 FOR: HONDA®**



**MLHY01 FOR: HYUNDAI<sup>®</sup>**



**MLHY02 FOR: HYUNDAI<sup>®</sup>**



**MLHY03 FOR: HYUNDAI<sup>®</sup>**



**MLHY-11.P5 FOR: HYUNDAI<sup>®</sup>**



**MLHY-11D.P2 FOR: HYUNDAI<sup>®</sup>**



**MLHY-11D.P6 FOR: HYUNDAI<sup>®</sup>**



**MLHY-11D.P7 FOR: HYUNDAI®**



**MLHY-18.P2 FOR: HYUNDAI®**



**MLHY-18.P4 FOR: HYUNDAI®**



**MLHY-18.P5 FOR: HYUNDAI®**



**MLHY-18.P6 FOR: HYUNDAI®**



**MLHY-18.P7 FOR: HYUNDAI®**



**MLHY-18.P8 FOR: HYUNDAI<sup>®</sup>**



**MLISU-3D.P3 FOR: ISUZU<sup>®</sup>**



**MLFI-13.P11 FOR: IVECO<sup>®</sup>**



**MLFI-13.P10 FOR: LANCIA<sup>®</sup>**



**MLFI-16.P3 FOR: LANCIA<sup>®</sup>**



**MLHU-HCA.P5 FOR: LANCIA<sup>®</sup>**



**MLHU-HCA.P7 FOR: LANCIA®**



**MLHU-HCA.P8 FOR: LANCIA®**



**MLNE-52.P3 FOR: LAND RANGE ROVER®**



**MLTOY001 FOR: LEXUS®**



**MLHU-HCA.P1 FOR: LEXUS®**



**MLHU-HCA.P2 FOR: LEXUS®**



**MLHU-HCA.P2**



**MLTOYO-15.P3 FOR: LEXUS<sup>®</sup>****2****MLTOYO-15.P5 FOR: LEXUS<sup>®</sup>****2****MLTOYO-15.P6 FOR: LEXUS<sup>®</sup>****3****MLTOYO-19.P2 FOR: LEXUS<sup>®</sup>****2****MLTOYO-30.P2 FOR: LEXUS<sup>®</sup>****3****MLTOYO-36.P1 FOR: LEXUS<sup>®</sup>****2**



**MLMAZ-11D.P3 FOR: MAZDA®**



**MLMAZ-21D.P2 FOR: MAZDA®**



**MLMAZ-21D.P3 FOR: MAZDA®**



**MLME01 FOR: MERCEDES®**



**MLME02 FOR: MERCEDES®**



**MLME03 FOR: MERCEDES®**



**MLME-2.P1 FOR: MERCEDES®**



**MLME-2.P2 FOR: MERCEDES®**



**MLME-2.P3 FOR: MERCEDES®**



**MLME-7.P1 FOR: MERCEDES®**



**MLME-7.P2 FOR: MERCEDES®**



**MLME-7.P3 FOR: MERCEDES®**



**MLBM-8.P1 FOR: MINI®**



**MLBM-8.P2 FOR: MINI®**



**MLBM-8.P3 FOR: MINI®**



**MLMIT01 FOR: MITSUBISHI®**



**MLMIT02 FOR: MITSUBISHI®**



**MLHU-DH.P4 FOR: MITSUBISHI®**



**MLMIT-8D.P3 FOR: MITSUBISHI<sup>®</sup>**



**MLMIT-8D.P4 FOR: MITSUBISHI<sup>®</sup>**



**MLMIT-8D.P5 FOR: MITSUBISHI<sup>®</sup>**



**MLMIT-12.P3 FOR: MITSUBISHI<sup>®</sup>**



**MLMIT-12.P4 FOR: MITSUBISHI<sup>®</sup>**



**MLNS01 FOR: NISSAN<sup>®</sup>**



**MLDAT-15.P6 FOR: NISSAN®**



**MLDAT-15.P7 FOR: NISSAN®**



**MLDAT-15.P8 FOR: NISSAN®**



**MLOP01 FOR: OPEL®**



TP00OP-11.TL  
TP00OP-D.TL  
TP00OP-S.TL  
TP00OP-WH.TL

**MLOP02 FOR: OPEL®**



TP00OP-11.TL  
TP00OP-D.TL  
TP00OP-S.TL  
TP00OP-WH.TL

**MLOP03 FOR: OPEL®**



TP00OP-11.TL2  
TP00OP-D.TL2  
TP00OP-S.TL2

**MLOP04 FOR: OPEL<sup>®</sup>****2****MLOP05 FOR: OPEL<sup>®</sup>****3** **MLOP-11.P3 FOR: OPEL<sup>®</sup>** **2****MLOP-11.P4 FOR: OPEL<sup>®</sup>** **3** **MLCIT-1.P8 FOR: OPEL<sup>®</sup>** **2****MLCIT-1.P9 FOR: OPEL<sup>®</sup>** **3**

**MLNE-38.P8** FOR: OPEL®



NE-60C3

**MLNE-38.P11** FOR: OPEL®



NE-60C3

**MLNE-38.P12** FOR: OPEL®



NE-60C3

**MLOP-11.P6** FOR: OPEL®



**MLOP-11.P7** FOR: OPEL®



**MLCIT01** FOR: PEUGEOT®





**MLCIT02 FOR: PEUGEOT<sup>®</sup>**



2

**MLCIT03 FOR: PEUGEOT<sup>®</sup>**



2

**MLCIT04 FOR: PEUGEOT<sup>®</sup>**



 2

**MLCIT-1.P1 FOR: PEUGEOT<sup>®</sup>**



 2 

MLCIT-1.P2

**MLCIT-1.P2 FOR: PEUGEOT<sup>®</sup>**



 2

 PEU-1C1

**MLCIT-1.P3 FOR: PEUGEOT<sup>®</sup>**



 2

 PEU-1C1

**MLCIT-1.P11 FOR: PEUGEOT®**



**MLCIT-1.P4 FOR: PEUGEOT®**



**MLCIT-1.P5 FOR: PEUGEOT®**



**MLCIT-1.P6 FOR: PEUGEOT®**



**MLCIT-1.P7 FOR: PEUGEOT®**



**MLCIT-1.P10 FOR: PEUGEOT®**



**MLFI01 FOR: PEUGEOT<sup>®</sup>**



**MLFI02 FOR: PEUGEOT<sup>®</sup>**



**MLHU-HCA.P1 FOR: PEUGEOT<sup>®</sup>**



**MLHU-HCA.P2**

**MLHU-HCA.P2 FOR: PEUGEOT<sup>®</sup>**



**MLHU-HCA.P3 FOR: PEUGEOT<sup>®</sup>**



**MLHU-HCA.P9 FOR: PEUGEOT<sup>®</sup>**



**MLHU-HCA.P4 FOR: PEUGEOT®**



**MLHU-HCA.P5 FOR: PEUGEOT®**



**MLHU-HCA.P6 FOR: PEUGEOT®**



**MLHU-HCA.P7 FOR: PEUGEOT®**



**MLHU-HCA.P8 FOR: PEUGEOT®**



**MLNE-38.P5 FOR: PEUGEOT®**



**MLNE-38.P6 FOR: PEUGEOT<sup>®</sup>**



**MLNE-38.P15 FOR: PEUGEOT<sup>®</sup>**



**MLNE-51.P3 FOR: PEUGEOT<sup>®</sup>**



MLNE-51.P4

**MLNE-51.P4 FOR: PEUGEOT<sup>®</sup>**



PEU-2C1

**MLNE-51.P5 FOR: PEUGEOT<sup>®</sup>**



PEU-2C1

**MLNE-51.P6 FOR: PEUGEOT<sup>®</sup>**



PEU-2C1

**MLSIX-3.P4 FOR: PEUGEOT®**



MLSIX-3.P5

**MLSIX-3.P5 FOR: PEUGEOT®**



**MLSIX-3.P7 FOR: PEUGEOT®**



**MLCIT-1.P1 FOR: RENAULT®**



MLCIT-1.P2

**MLCIT-1.P2 FOR: RENAULT®**



PEU-1C1

**MLCIT-1.P8 FOR: RENAULT®**



**MLCIT-1.P9 FOR: RENAULT®**



**MLCIT-1.P12 FOR: RENAULT®**



**MLCIT-1.P13 FOR: RENAULT®**



**MLNE-38.P7 FOR: RENAULT®**



**MLNE-38.P8 FOR: RENAULT®**



**MLNE-38.P9 FOR: RENAULT®**





**MLNE-38.P10 FOR: RENAULT®**



NE-60C3

**MLNE-38.P11 FOR: RENAULT®**



NE-60C3

**MLNE-38.P12 FOR: RENAULT®**



NE-60C3

**MLNE-38.P13 FOR: RENAULT®**



NE-60C3

**MLNE-38.P14 FOR: RENAULT®**



NE-60C3

**MLVA-34.P5 FOR: RENAULT®**



VA-61C3

**MLVA-34.P6 FOR: RENAULT®**



VA-61C3

**MLVA-34.P7 FOR: RENAULT®**



VA-61C3

**MLVA-34.P8 FOR: RENAULT®**



VA-61C3

**MLVA-34.P9 FOR: RENAULT®**



VA-61C3

**MLVA-34.P10 FOR: RENAULT®**



VA-61C3

**MLRV01 FOR: ROVER®**



**MLBM-8.P3 FOR: ROVER®**



**MLNE-52.P4 FOR: ROVER®**



**MLSAA-3.P2 FOR: SAAB®**



**SAA-3.P2C2**

**MLV001 FOR: SEAT®**



TPO0HU-HAA.TLN

**MLV002 FOR: SEAT®**



TPO0HU-HAA.TLN

**MLV003 FOR: SEAT®**



**MLV004 FOR: SEAT<sup>®</sup>**



**MLV001 FOR: SKODA<sup>®</sup>**



TPO0HU-HAA.TLN

**MLV002 FOR: SKODA<sup>®</sup>**



TPO0HU-HAA.TLN

**MLV003 FOR: SKODA<sup>®</sup>**



**MLV004 FOR: SKODA<sup>®</sup>**



**MLSMR01 FOR: SMART<sup>®</sup>**



**MLSMR02 FOR: SMART®**



1

**MLSMR03 FOR: SMART®**



3 

**MLME-HY.P1 FOR: SMART®**



 3 

**MLME-HY.P2 FOR: SMART®**



 1

**MLSMR-1.P1 FOR: SMART®**



 3 

**MLSSA-1.P2 FOR: SSANGYONG®**



 2

**MLSUB-2.P1 FOR: SUBARU<sup>®</sup>****MLSUB-2.P3 FOR: SUBARU<sup>®</sup>****MLSUB-2.P4 FOR: SUBARU<sup>®</sup>****MLSUB-3.P3 FOR: SUBARU<sup>®</sup>****MLSUB-3.P4 FOR: SUBARU<sup>®</sup>****MLISU-3D.P4 FOR: SUBARU<sup>®</sup>**

**MLSUZU01 FOR: SUZUKI®**



**MLSZ01 FOR: SUZUKI®**



**MLSUZU-14.P3 FOR: SUZUKI®**



**MLSUZU-14.P4 FOR: SUZUKI®**



SUZU-14.P4C1

**MLTOYO-15.P9 FOR: SUZUKI®**



**MLTOY001 FOR: TOYOTA®**





**MLTOY002 FOR: TOYOTA®**



**MLKI-9.P1 FOR: TOYOTA®**



**MLCIT-1.P15 FOR: TOYOTA®**



**MLCIT-1.P16 FOR: TOYOTA®**



**MLTOYO-15.P3 FOR: TOYOTA®**



**MLTOYO-15.P4 FOR: TOYOTA®**



**MLTOYO-15.P5 FOR: TOYOTA®**



**MLTOYO-15.P6 FOR: TOYOTA®**



**MLTOYO-15.P7 FOR: TOYOTA®**



**MLTOYO-19.P1 FOR: TOYOTA®**



**MLTOYO-19.P2 FOR: TOYOTA®**



**MLTOYO-19.P3 FOR: TOYOTA®**



**MLTOYO-20D.P2 FOR: TOYOTA®**



**MLTOYO-20D.P3 FOR: TOYOTA®**



**MLTOYO-30.P2 FOR: TOYOTA®**



**MLTOYO-36.P1 FOR: TOYOTA®**



**MLTOYO-43.P1 FOR: TOYOTA®**



**MLV001 FOR: VOLKSWAGEN®**



TPO0HU-HAA.TLN

**MLV002 FOR: VOLKSWAGEN®**



TP00HU-HAA.TLN

**MLV003 FOR: VOLKSWAGEN®**



**MLV004 FOR: VOLKSWAGEN®**



**MLHU-HAA.P3 FOR: VOLKSWAGEN®**



**MLHU-HAA.P4 FOR: VOLKSWAGEN®**



HU-HAAC1

**MLHU-HAA.P5 FOR: VOLKSWAGEN®**



HU-HAAC1

**MLHU-HAA.P6 FOR: VOLKSWAGEN<sup>®</sup>****2**  
**HU-HAAC1**



***OTROS***  
***OTHERS***

***BESTE BATZUK AUTRES ANDERE OUTRAS INNE***

**FOR DACIA<sup>®</sup>**

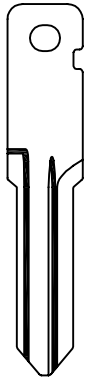

DAC-6C1

**FOR FORD<sup>®</sup>**

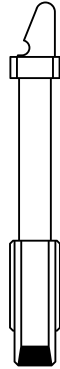

ALP.



FO-6C1

**FOR HUF<sup>®</sup>**

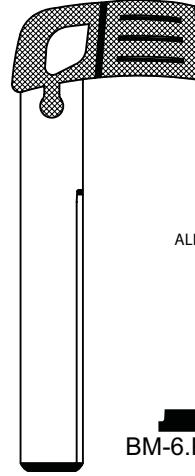

ALP.

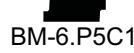

BM-6.P5C1

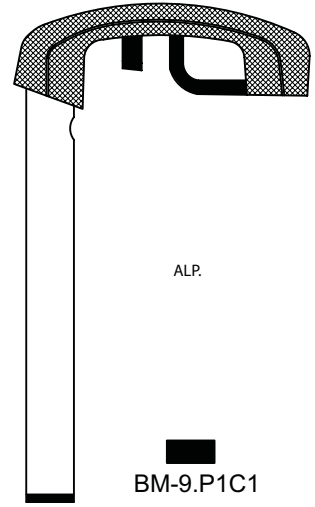

ALP.



BM-9.P1C1

**FOR HUF<sup>®</sup>**

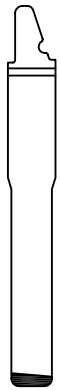

ALP.

FO-24C2

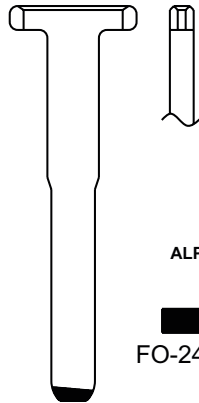

ALP.

FO-24C3

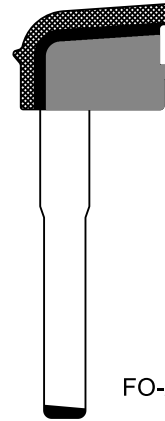

ALP.

FO-24.P3C10



ALP.

HU-HAAC1

**FOR HUF<sup>®</sup>**



ALP.

HU-HCAC1

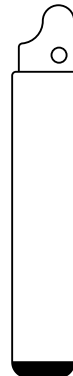

LAT.

HU-HCAC3

**FOR HYUNDAI<sup>®</sup>**

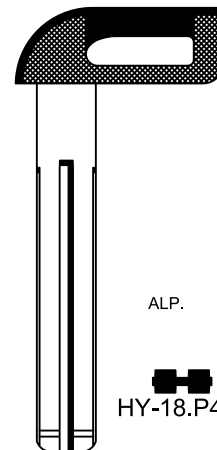

ALP.

HY-18.P4C2



# ESPADINES/BLADES

FOR NEIMAN®

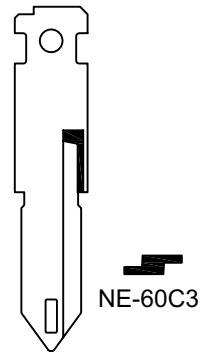
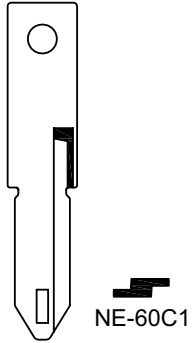

FOR SAAB®

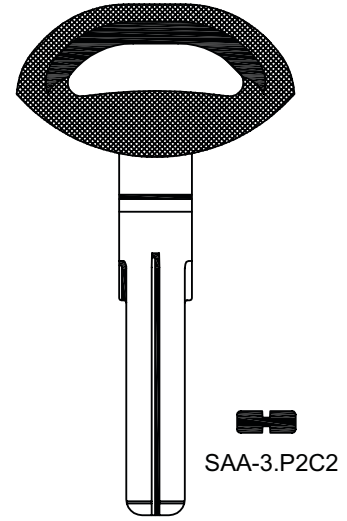

FOR SUZUKI®

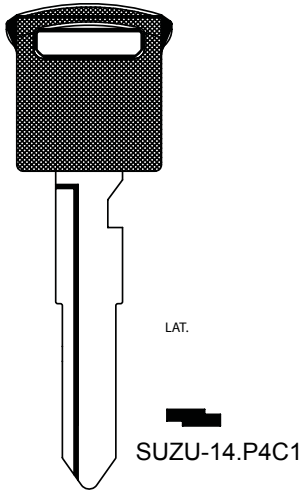

FOR TRW-SIPEA®

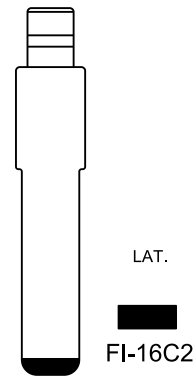
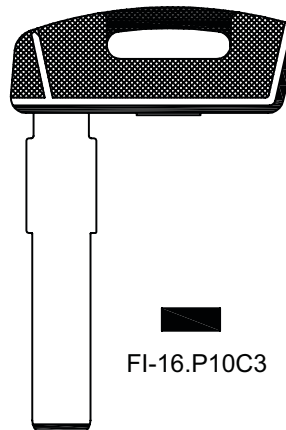

FOR VACHETTE®

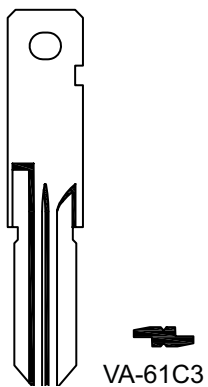

FOR VALEO®

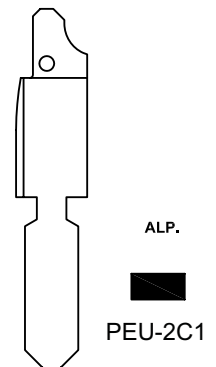
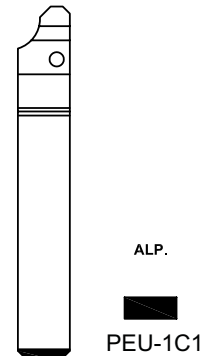
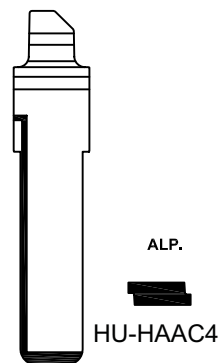

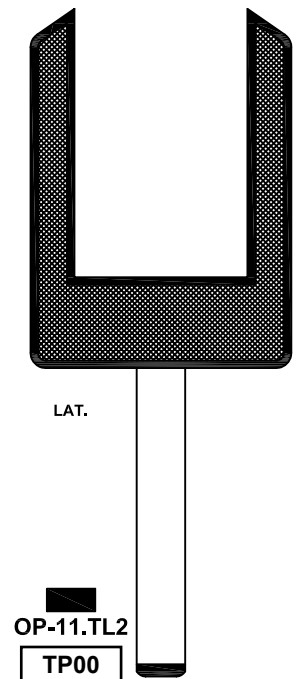
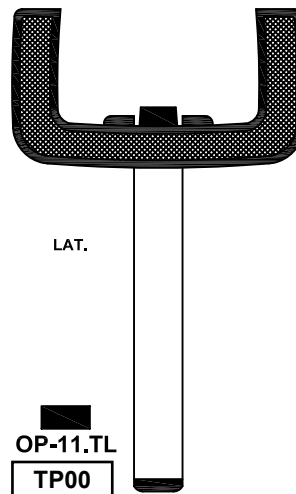
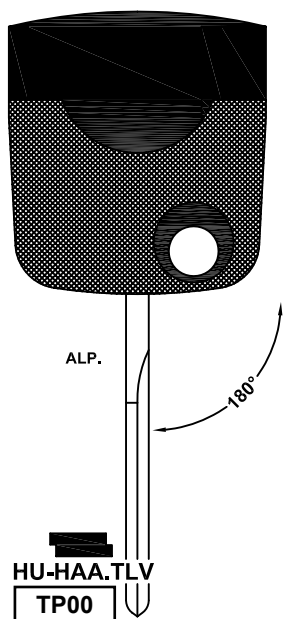
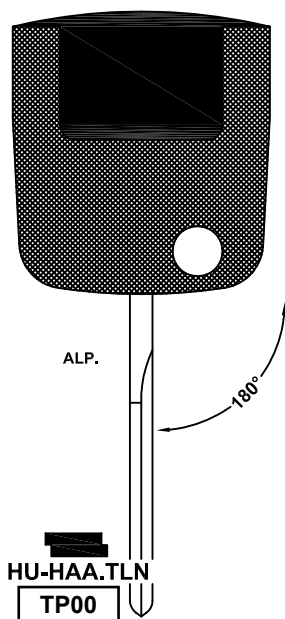
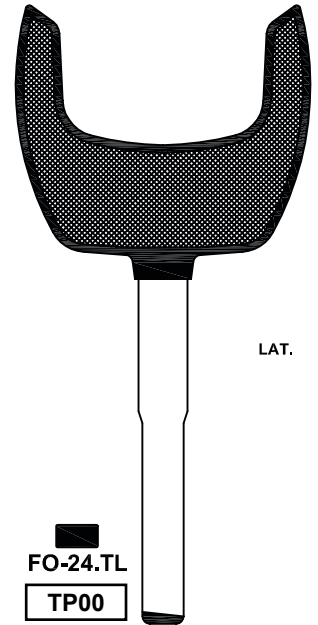
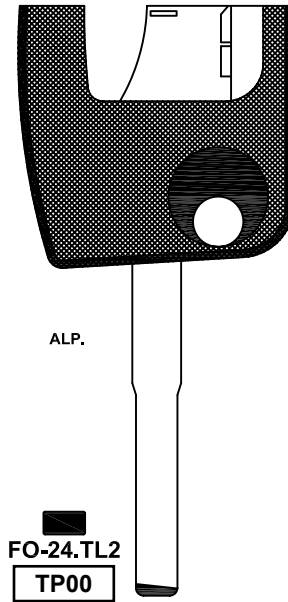
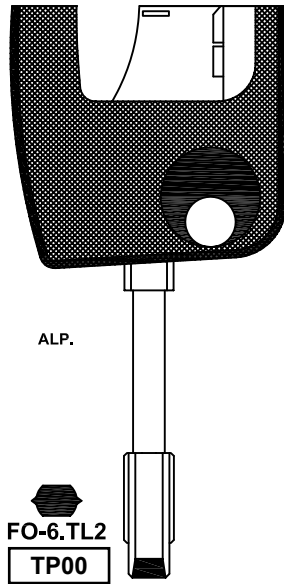
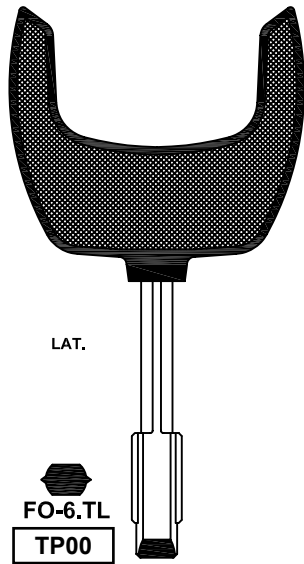

# TL / HORSESHOES

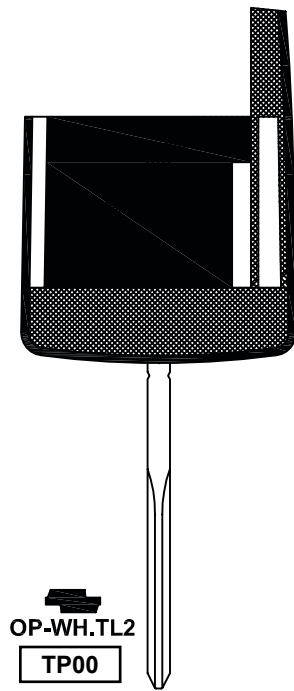
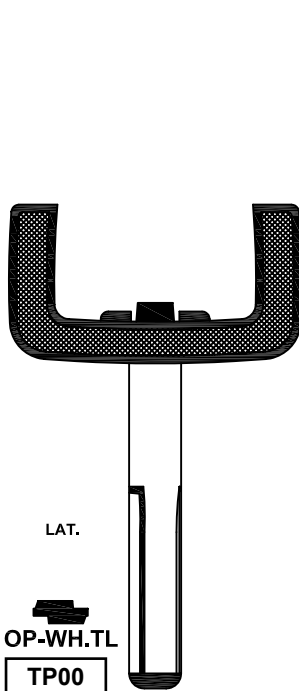
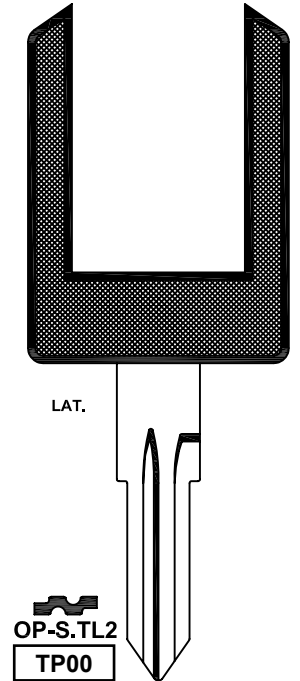
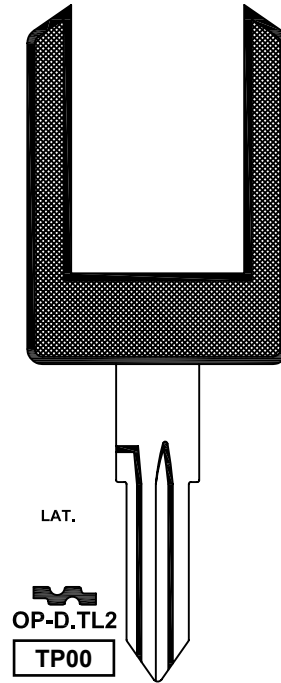
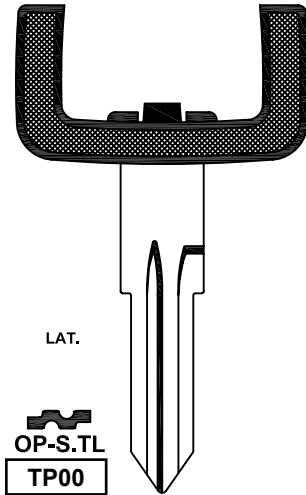
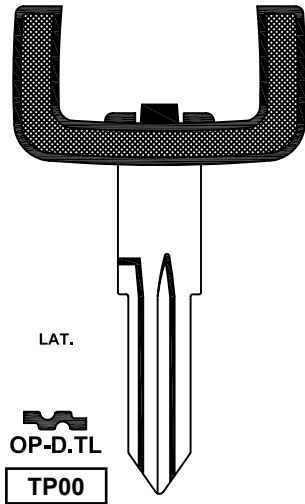



## SWITCH BLADE

**Soporte para cambio de espadines de las llaves escamoteables.**

**160 x 100 x 30 mm (ancho x largo x altura)**

*Support jig to enable easy and safe changing of blade of flipkey keys.*

*160 x 100 x 30 mm (width x length x height)*



## KIT PUNZONES / PUNCH KIT

**KIT Punzones para Switch Blade.**

*Punch KIT for Switch Blade.*









**JMA SPAIN**

JMA ALEJANDRO ALTUNA, S.L.U.  
Tel +34 943 79 30 00  
Bidekurtzeta, 6 P.O.Box - Apdo. 70  
20500 Arrasate - Mondragón  
Gipuzkoa – SPAIN  
[www.jma.es](http://www.jma.es)  
[ventas@jma.es](mailto:ventas@jma.es)

**JMA FRANCE**

JMA FRANCE SAS  
Tel +33 01 39 22 42 10  
Technoparc  
13, rue Edouard Jeanneret  
F- 78306 Poissy Cedex  
[www.jmafrance.fr](http://www.jmafrance.fr)  
[service.commercial@jmafrance.fr](mailto:service.commercial@jmafrance.fr)

**JMA POLSKA**

JMA POLSKA Sp. z o.o.  
Tel +48 42 635 12 80  
91- 342 Łódź, ul. Zbąszyńska 3  
[www.jmapolska.pl](http://www.jmapolska.pl)  
[biuro@jmapolska.pl](mailto:biuro@jmapolska.pl)

**JMA PORTUGAL**

ALTUNA PORTUGAL  
COMERCIO DE CHAVES UNIPessoAL, LDA.  
Tel +351 219 947 470  
Rua de Goa Nº22  
2690-356 Santa Iria de Azoia  
[www.jmaportugal.com](http://www.jmaportugal.com)  
[comercial@jmaportugal.com](mailto:comercial@jmaportugal.com)

**JMA UK**

SKS T/A JMA UK  
Tel +44 144 229 1400  
Unit 2, Canalside Northbridge Road  
Berkhamsted  
Herts HP4 1EG  
[www.jma-uk.co.uk](http://www.jma-uk.co.uk)  
[sales@jma-uk.co.uk](mailto:sales@jma-uk.co.uk)

**JMA MAROC S.A.R.L.**

Tel +0520 150 535  
83,85 Bd Oued ZIZ, El Oulfa  
Casablanca  
[www.jma.ma](http://www.jma.ma)  
[jma@jma.ma](mailto:jma@jma.ma)

**JMA MEXICO**

LLAVES ALTUNA DE MEXICO S.A de C.V  
Tel +52 33 3777 1600  
Av. Aviación No. 5520  
Col. San Juan de Ocotán  
C.P. 45019 Zapopan, Jalisco  
[www.jma.com.mx](http://www.jma.com.mx)  
[ventas@jma.com.mx](mailto:ventas@jma.com.mx)

**JMA PERU**

JMA PERU S.A.C.  
Tel +51 639 9300  
Av. Los Paracas 130,  
Urbanización Salamanca,  
Distrito Ate, Lima  
[www.jma-peru.com](http://www.jma-peru.com)  
[info@jma-peru.com](mailto:info@jma-peru.com)

**JMA COLOMBIA**

IFAM - JMA Colombia, S.A.S.  
tel +57 1 53333246  
Fax +57 3203497446  
Diagonal 115A - 70B - 45 Local 1  
Bogotá  
[www.jmacolombia.com](http://www.jmacolombia.com)  
[info@jmacolombia.com](mailto:info@jmacolombia.com)

**JMA USA**

ALTUNA GROUP USA INC.  
Tel +1 817 385 0515  
1513 Greenview Drive  
75050 Grand Prairie  
Texas  
[www.jmausa.com](http://www.jmausa.com)  
[info@jmausa.com](mailto:info@jmausa.com)

Tel +34 943 79 30 00  
Fax +34 943 79 72 43  
Bidekurtzeta, 6 P.O.Box - Apdo. 70  
Arrasate - Mondragón 20500  
Gipuzkoa – SPAIN

Member of  
**Altuna Group**